



**SPIRIT** FITNESS

*A Heritage of Quality | The Spirit of Innovation*

# Инструкция по сборке скамьи для жима с положительным наклоном



Руководство пользователя



*A Heritage of Quality | The Spirit of Innovation*  
**SPIRIT** FITNESS



*A Heritage of Quality | The Spirit of Innovation*  
**SPIRIT** FITNESS



*A Heritage of Quality | The Spirit of Innovation*  
**SPIRIT** FITNESS

# 1

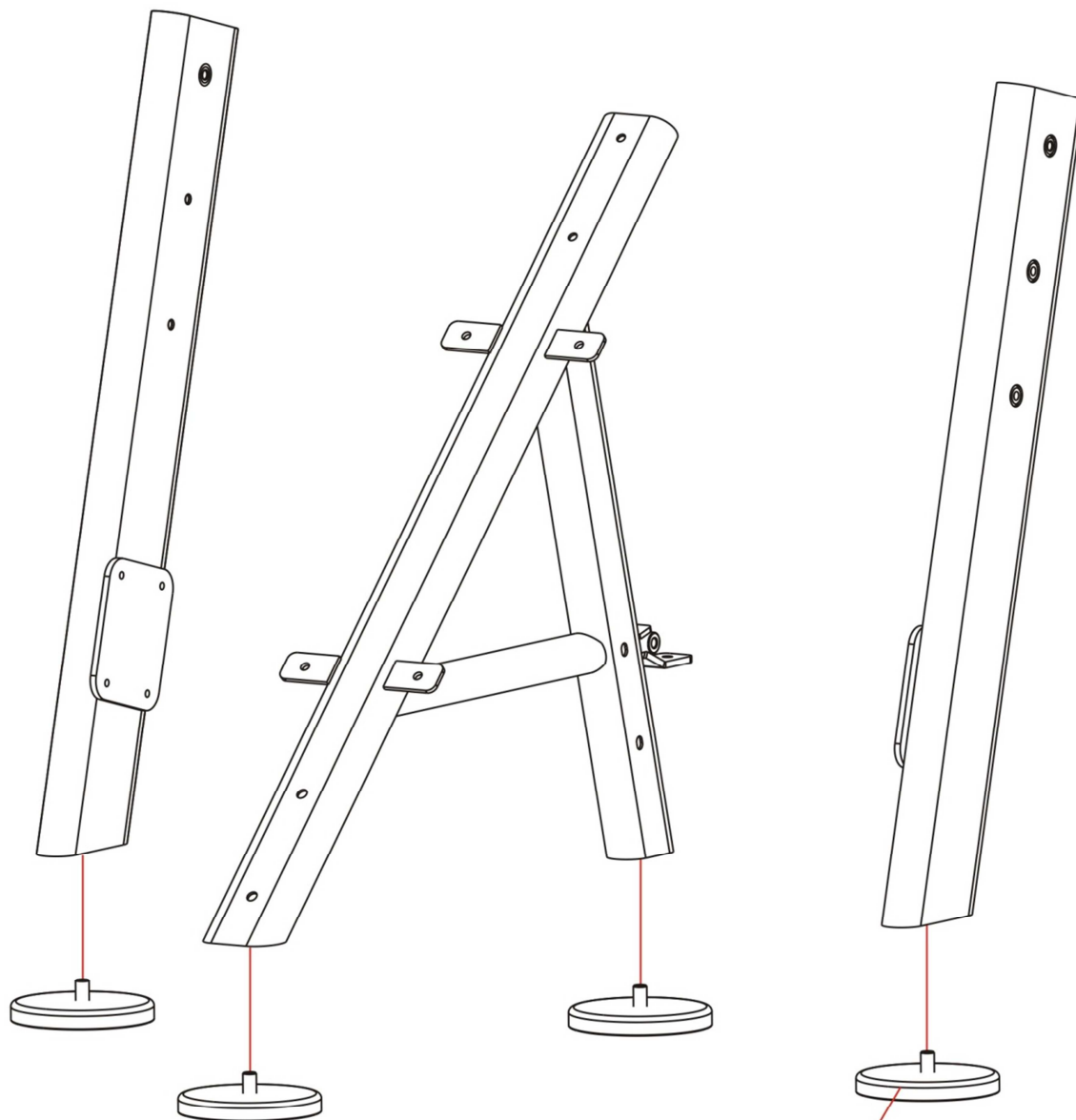





23

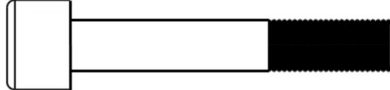

23  X4  
Φ170X25



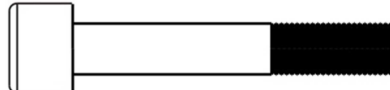

# 3

6  X1  
M10X75 

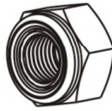

7  X3  
M10X85 

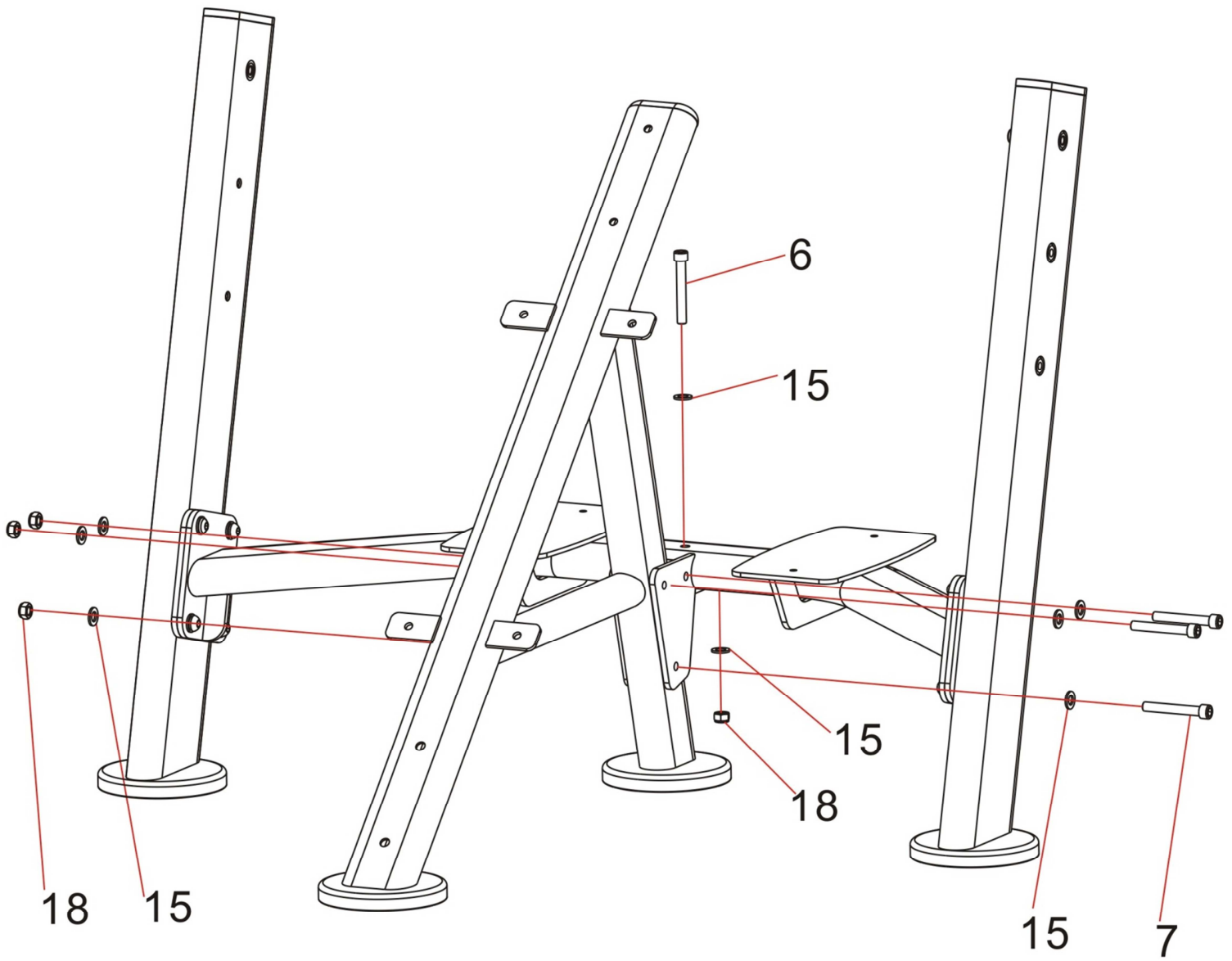

15  X8  
M10 

18  X4  
M10 

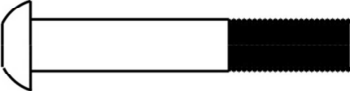

# 4





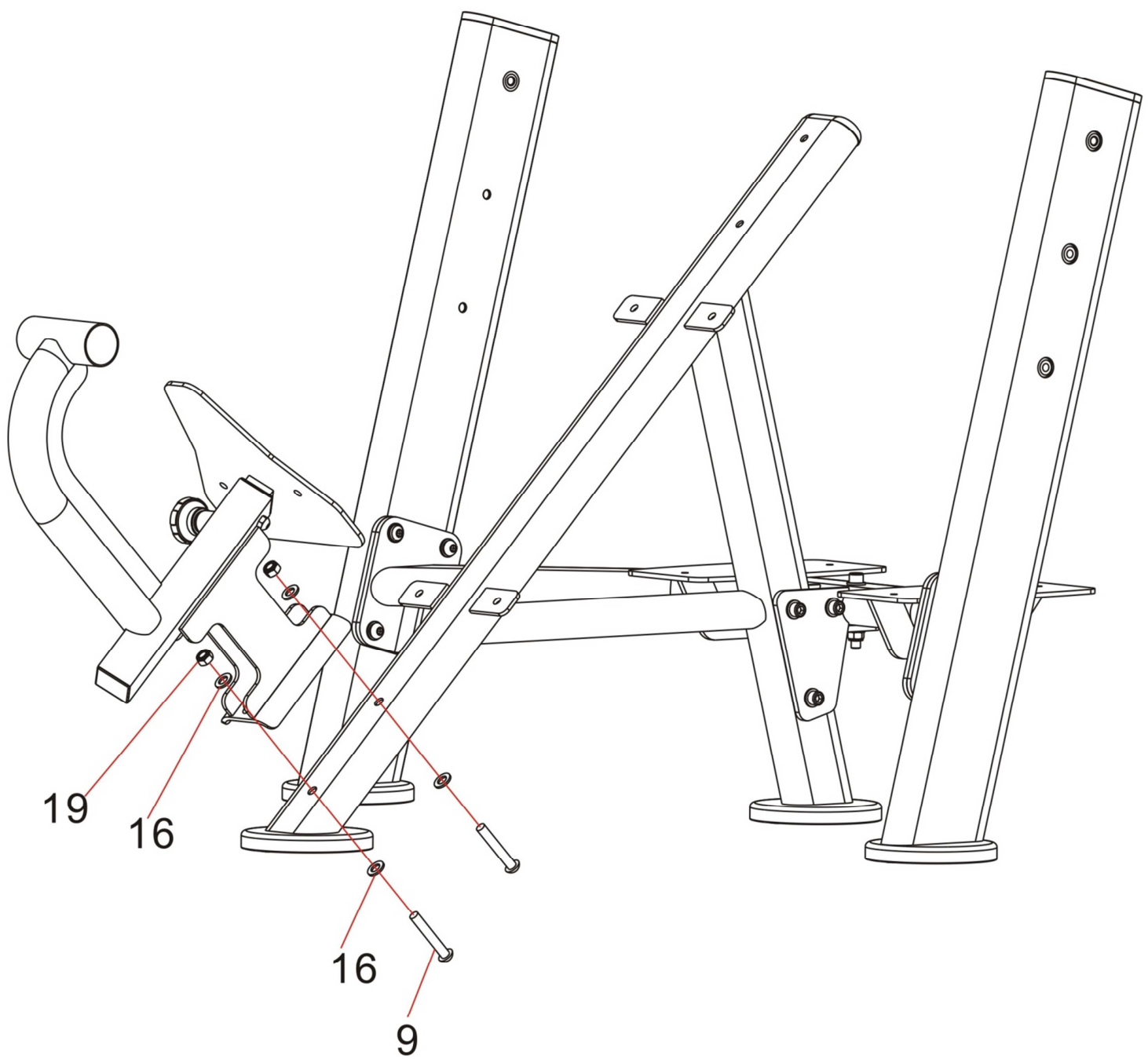

9  X2  
M12X75 

16  X4  
M12 

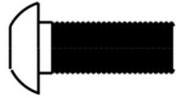
19  X2  
M12 





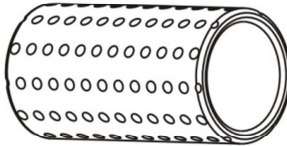

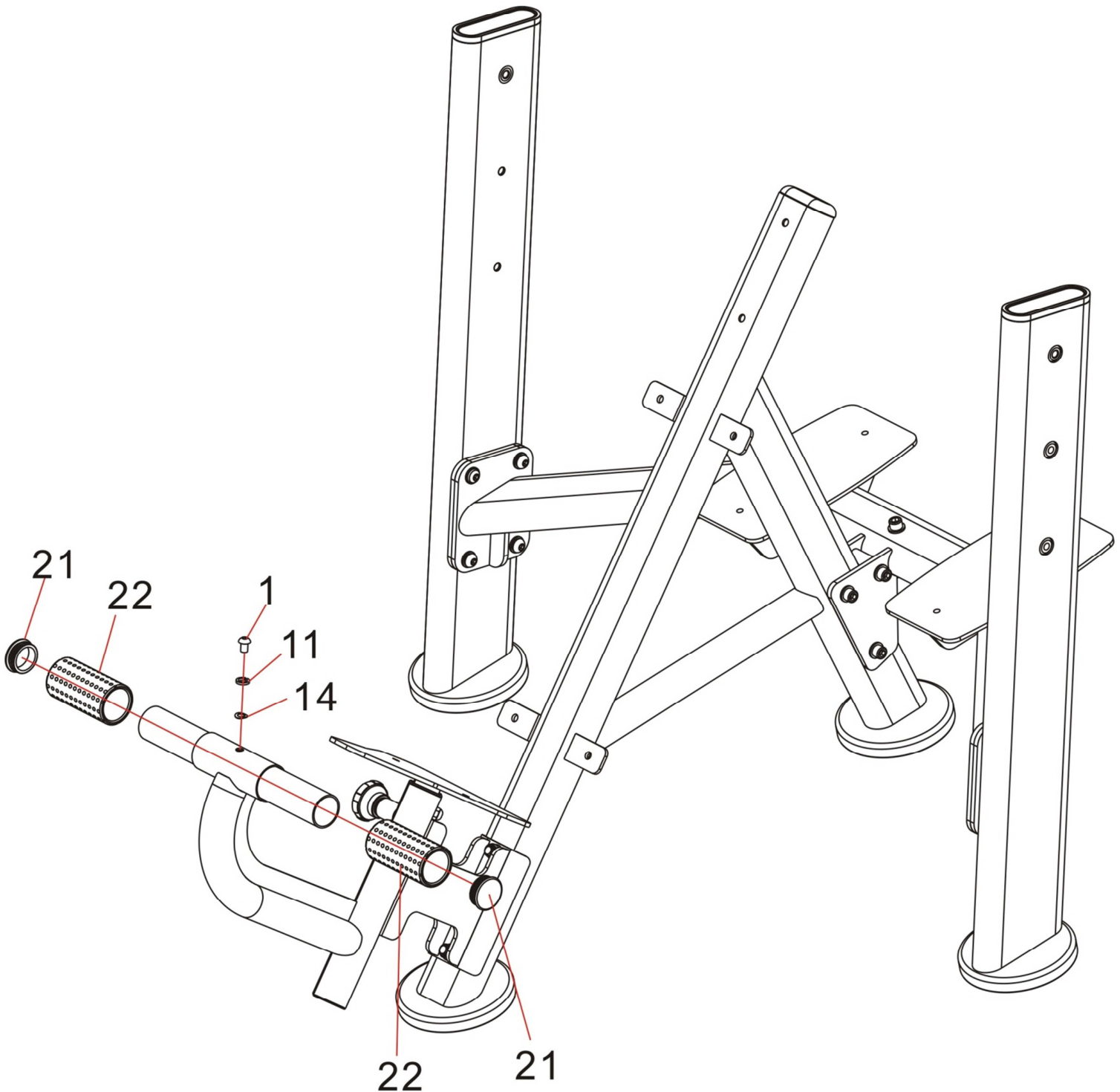
# 5

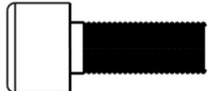

- 1  X1  
M10X20 
- 14  X1  
M10 
- 11  X9  
M10 
- 21  X2  
 $\Phi 50 \times 2.5$
- 22  X2  
 $\Phi 49 \times \Phi 61 \times 120$



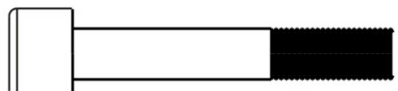



# 6

8  X6  
M12X25 

10  X4  
M12X85 

12  X10  
M12 

16  X14  
M12 

20  X4  
M12 

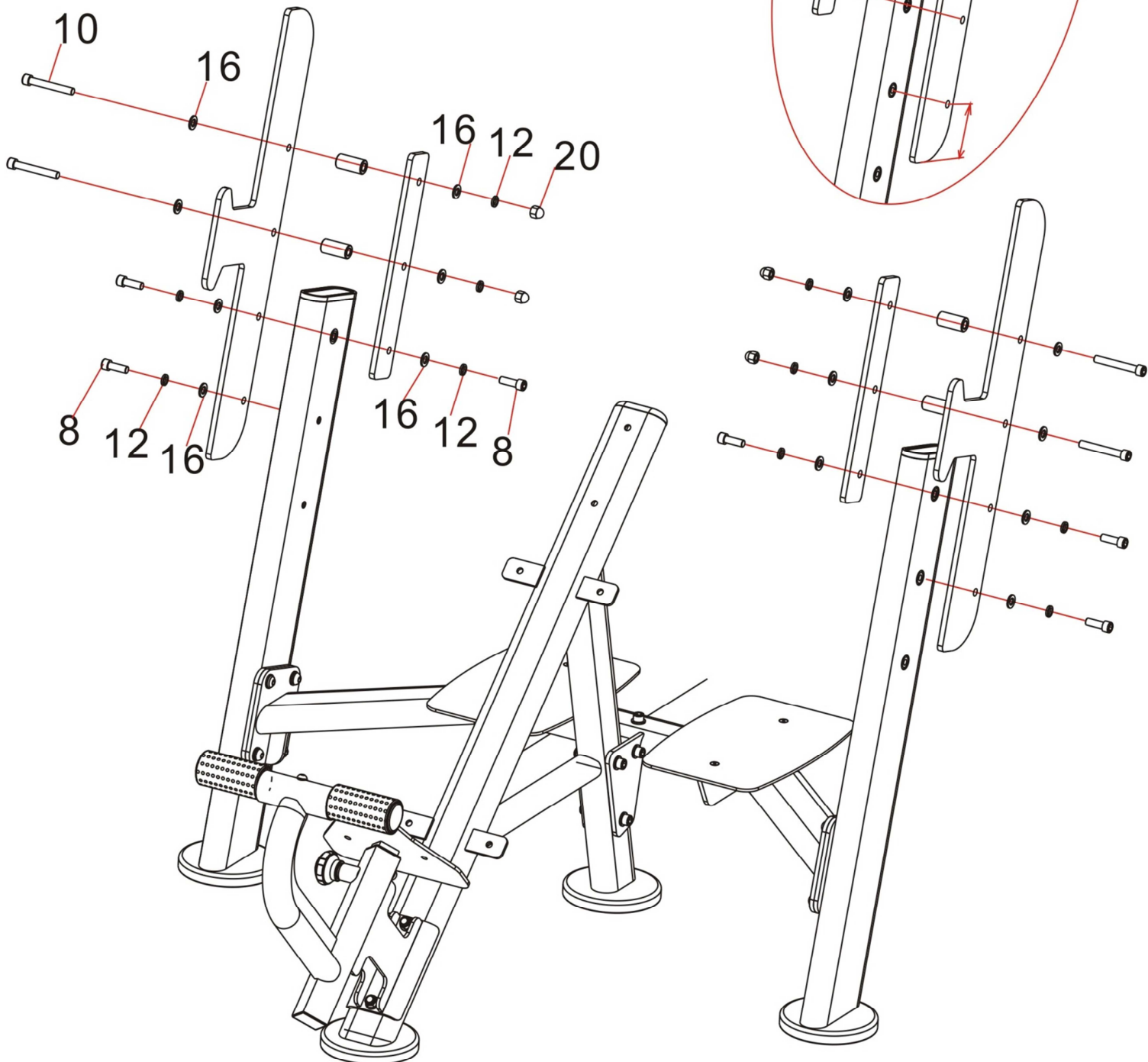

# 7

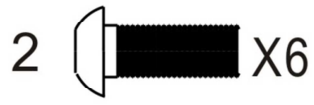

M10X35

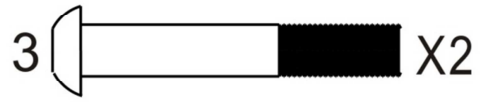

M10X80





M10



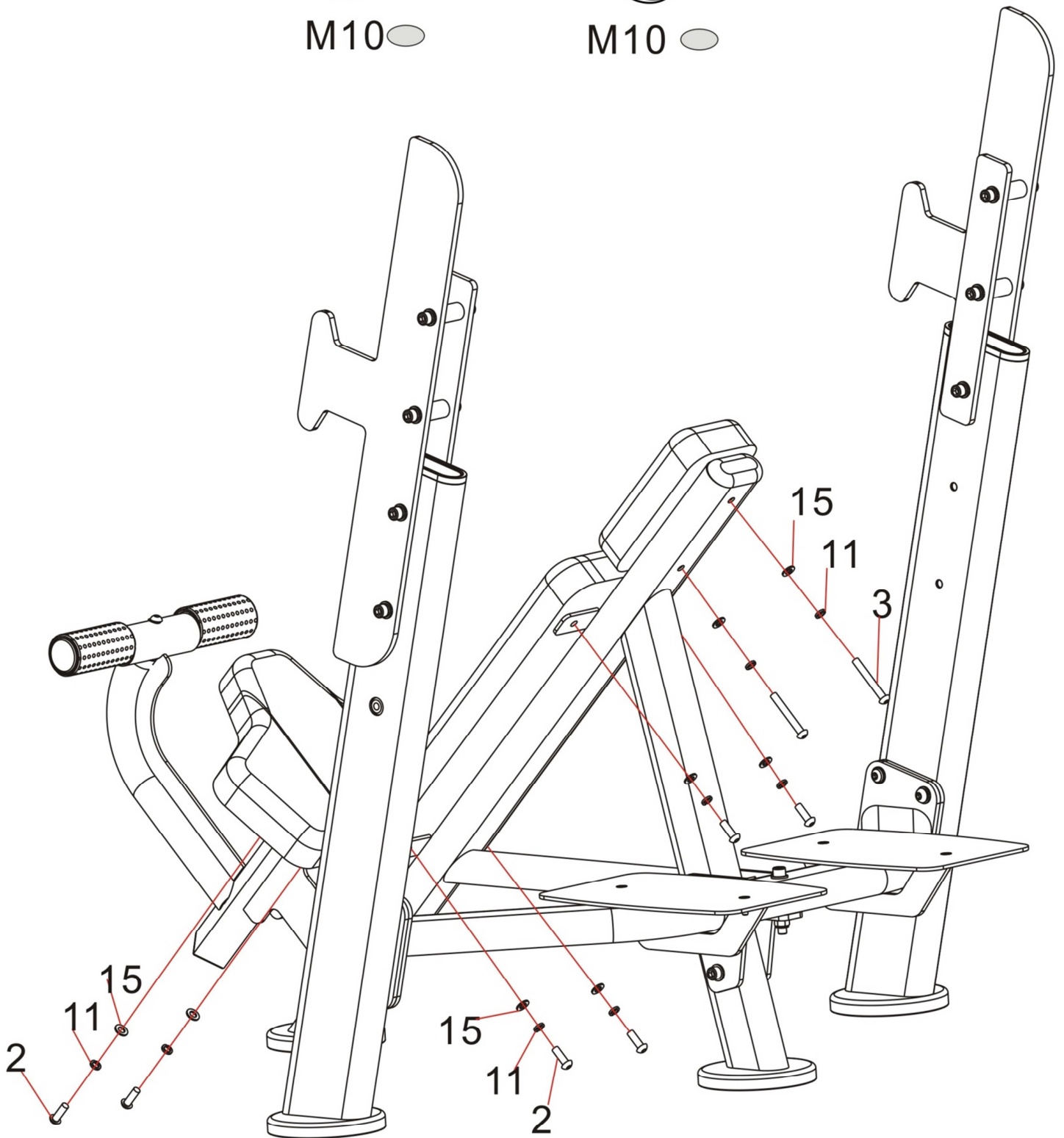



M10



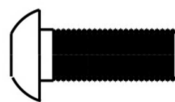



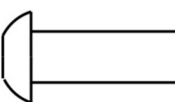

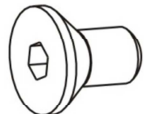

1  X1  
M10X20 

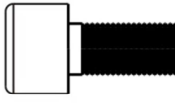

2  X6  
M10X35 

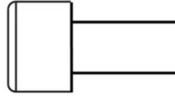

3  X2  
M10X80 

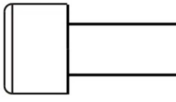

4  X4  
M8X25 

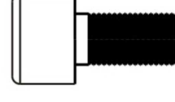

5  X8  
M10X25 

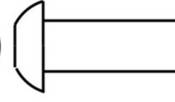

6  X1  
M10X75 

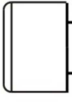

7  X3  
M10X85 



8  X6  
M12X25 



9  X2  
M12X75 



10  X4  
M12X85 



11  X17  
M10 



12  X10  
M12 



13  X4  
M8 

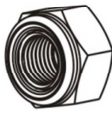

14  X1  
M10 

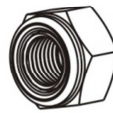

15  X24  
M10 

16  X18  
M12 

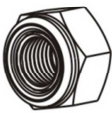
17  X4  
M8 

18  X4  
M10 

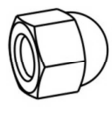
19  X2  
M12 

20  X4  
M12 

21  X2  
Φ50X2.5

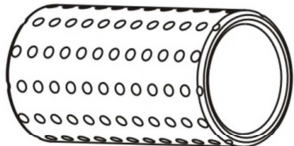
22  X2  
Φ49XΦ61X120

23  X4  
Φ170X25